

SOT-523 Plastic-Encapsulate MOSFETS

N-Channel 20-V(D-S) MOSFET

FEATURE

- Low $R_{DS(on)}$ Improving System Efficiency
- Low Threshold Voltage ,1.5V Rated
- ESD Protected Gate
- Pb-Free Packages are Available

APPLICATIONS

- Load/Power Switches
- Power Supply Converter Circuits
- Battery Management
- Portables like Cell Phones, PDAs, Digital Cameras, Pagers,etc

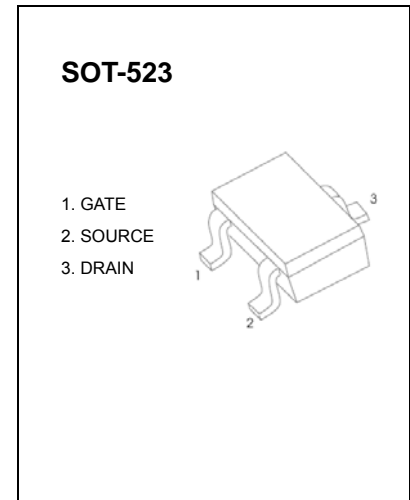

MARKING: X

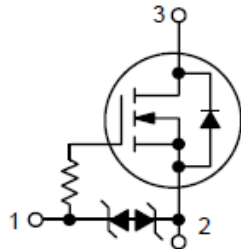

Maximum ratings ($T_a=25^{\circ}\text{C}$ unless otherwise noted)

Parameter	Symbol	Value	Unit
Drain-Source Voltage	V_{DS}	20	V
Gate-Source Voltage	V_{GS}	± 6	
Continuous Drain Current (note 1)	I_D	0.915	A
Power Dissipation (note 1)	P_D	150	mW
Thermal Resistance from Junction to Ambient (note 1)	$R_{\theta JA}$	833	$^{\circ}\text{C}/\text{W}$
Operating Junction Temperature	T_J	150	$^{\circ}\text{C}$
Storage Temperature	T_{stg}	-55~+150	

Electrical characteristics ($T_a=25^\circ\text{C}$ unless otherwise noted)

Parameter	Symbol	Test Condition	Min	Typ	Max	Unit
OFF CHARACTERISTICS						
Drain-source breakdown voltage	$V_{(BR)DSS}$	$V_{GS} = 0V, I_D = 250\mu A$	20			V
Gate-source leakage	I_{GSS}	$V_{DS} = 0V, V_{GS} = \pm 4.5V$			± 1	μA
Zero gate voltage drain current	I_{DSS}	$V_{DS} = 16V, V_{GS} = 0V$			100	nA
ON CHARACTERISTICS (note 2)						
Gate-source threshold voltage	$V_{GS(th)}$	$V_{DS} = V_{GS}, I_D = 250\mu A$	0.45		1.1	V
Drain-source on-state resistance	$R_{DS(on)}$	$V_{GS} = 4.5V, I_D = 600mA$			570	m Ω
		$V_{GS} = 2.5V, I_D = 500mA$			620	
		$V_{GS} = 1.8V, I_D = 350mA$			700	
		$V_{GS} = 1.5V, I_D = 40mA$			9500	
Forward transconductance	g_{fs}	$V_{DS} = 10V, I_D = 400mA$	0.5			S
CHARGES AND CAPACITANCES (note 3)						
Input Capacitance	C_{iss}	$V_{DS} = 16V, V_{GS} = 0V, f = 1MHz$		110		pF
Output Capacitance	C_{oss}			16		
Reverse Transfer Capacitance	C_{rss}			12		
Total Gate Charge	Q_g	$V_{DS} = 10V, V_{GS} = 4.5V, I_D = 200mA$		1.82		nC
Gate-Source Charge	Q_{gs}			0.3		
Gate-Drain Charge	Q_{gd}			0.42		
SWITCHING CHARACTERISTICS (note 3,4)						
Turn-on delay time	$t_{d(on)}$	$V_{DD} = 10V, V_{GS} = 4.5V, R_G = 10\Omega, I_D = 200mA$		3.7		ns
Rise time	t_r			4.4		
Turn-off delay time	$t_{d(off)}$			25		
Fall time	t_f			7.6		
DRAIN-SOURCE DIODE CHARACTERISTICS						
Body diode voltage	V_{SD}	$I_S = 0.2A, V_{GS} = 0V$			1.1	V

Notes :

1. Surface mounted on FR4 board using 1 in sq pad size.
2. Pulse Test : Pulse width $\leq 300\mu s$, Duty cycle $\leq 2\%$.
3. Guaranteed by design, not subject to production testing.
4. Switching characteristics are independent of operating junction temperatures.

Typical Characteristics

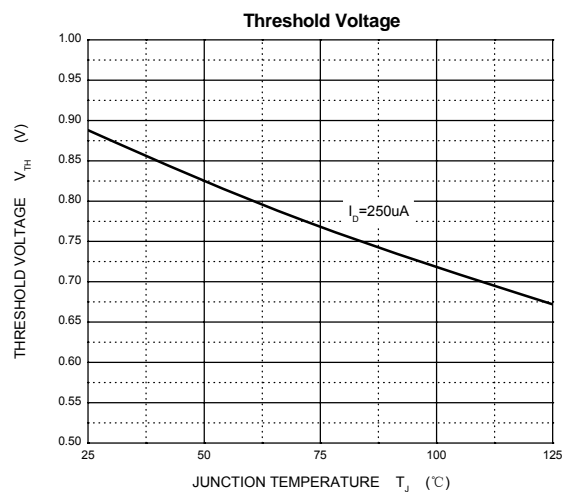
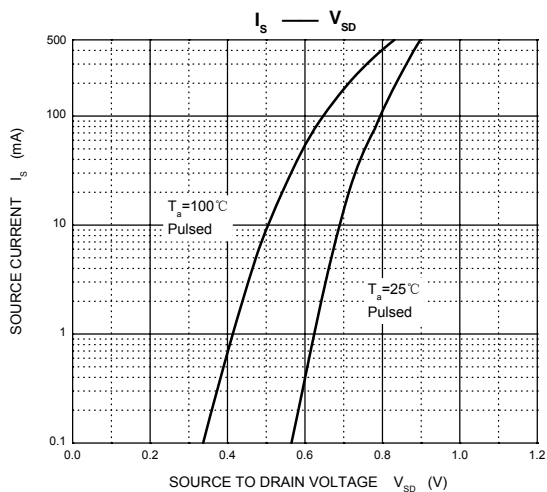
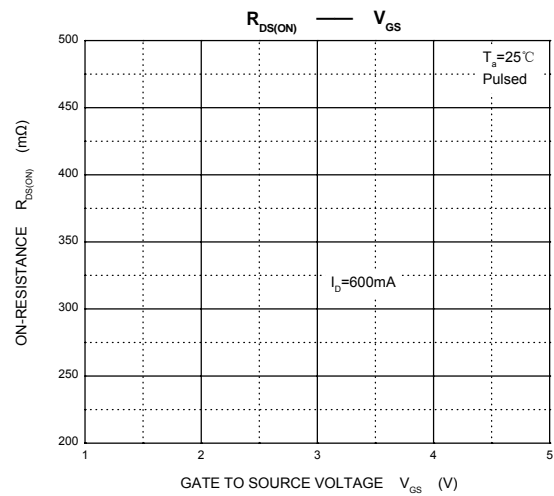
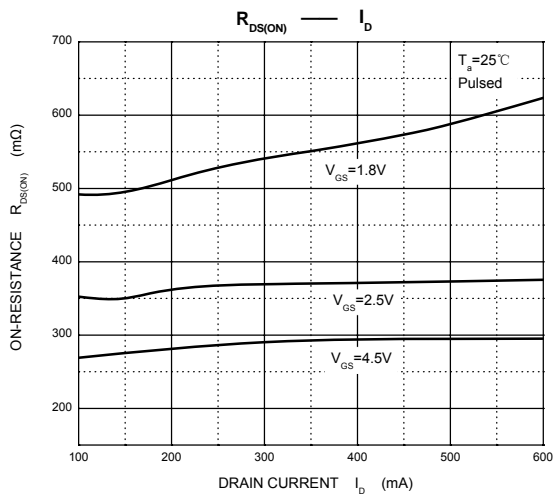
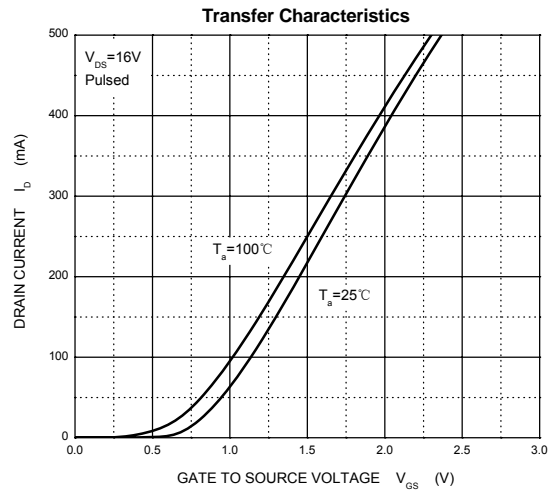
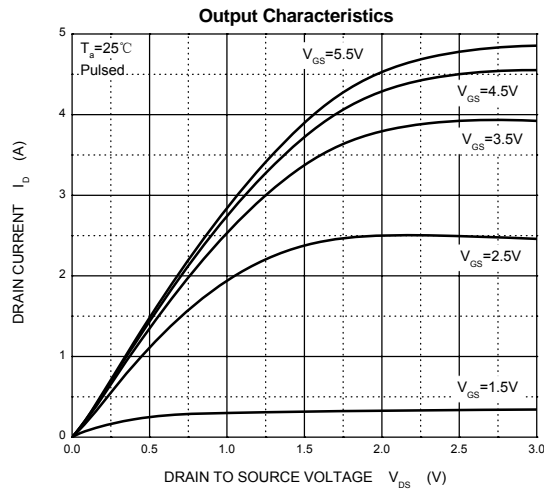



PACKAGE OUTLINE

Plastic surface mounted package; 3 leads

SOT-523

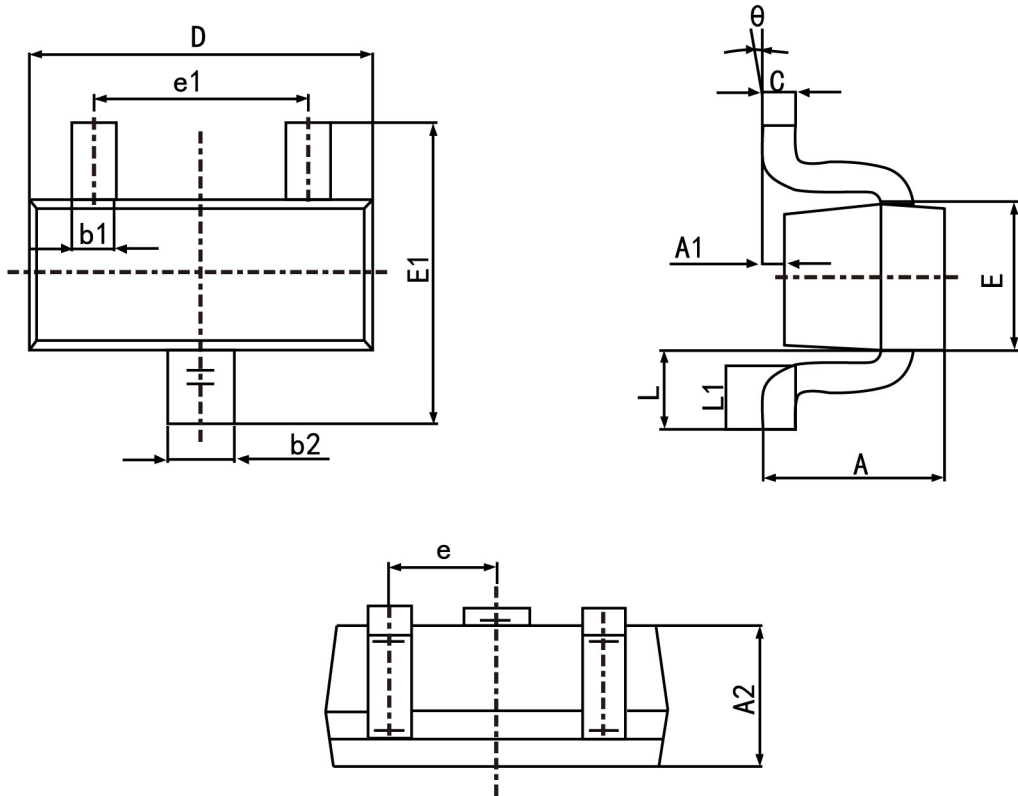

Symbol	Dimension in Millimeters	
	Min	Max
A	0.700	0.900
A1	0.000	0.100
A2	0.700	0.800
b1	0.150	0.250
b2	0.250	0.350
c	0.100	0.200
D	1.500	1.700
E	0.700	0.900
E1	1.450	1.750
e	0.500	TYP.
e1	0.900	1.100
L	0.400 REF.	
L1	0.260	0.460
theta	0°	8°