

### SOT23-3L Plastic-Encapsulate MOSFETS

N-Channel 20-V(D-S) MOSFET

#### FEATURE

TrenchFET Power MOSFET

#### APPLICATIONS

- Load Switch for Portable Devices
- DC/DC Converter

MARKING: 2302

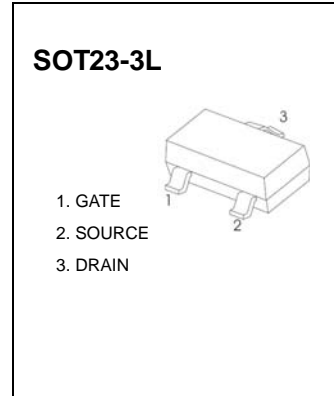
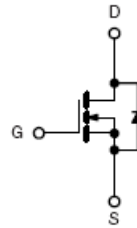

Maximum ratings ( $T_a=25^{\circ}\text{C}$  unless otherwise noted)

Parameter	Symbol	Value	Unit
Drain-Source Voltage	$V_{DS}$	20	V
Gate-Source Voltage	$V_{GS}$	$\pm 8$	
Continuous Drain Current	$I_D$	2.1	A
Continuous Source-Drain Current(Diode Conduction)	$I_S$	0.6	
Power Dissipation	$P_D$	0.35	W
Thermal Resistance from Junction to Ambient ( $t \leq 5s$ )	$R_{\theta JA}$	357	$^{\circ}\text{C}/\text{W}$
Operating Junction	$T_J$	150	$^{\circ}\text{C}$
Storage Temperature	$T_{STG}$	-55 ~+150	

**Electrical characteristics (T<sub>a</sub>=25°C unless otherwise noted)**

Parameter	Symbol	Test Condition	Min	Typ	Max	Units
<b>Static</b>						
Drain-source breakdown voltage	V <sub>(BR)DSS</sub>	V <sub>GS</sub> = 0V, I <sub>D</sub> = 10μA	20			V
Gate-threshold voltage	V <sub>GS(th)</sub>	V <sub>DS</sub> = V <sub>GS</sub> , I <sub>D</sub> = 250μA	0.60	0.95	1.2	
Gate-body leakage	I <sub>GSS</sub>	V <sub>DS</sub> = 0V, V <sub>GS</sub> = ±8V			±100	nA
Zero gate voltage drain current	I <sub>DSS</sub>	V <sub>DS</sub> = 20V, V <sub>GS</sub> = 0V			1	μA
Drain-source on-resistance <sup>a</sup>	r <sub>DS(on)</sub>	V <sub>GS</sub> = 4.5V, I <sub>D</sub> = 3.6A		0.045	0.060	Ω
		V <sub>GS</sub> = 2.5V, I <sub>D</sub> = 3.1A		0.070	0.115	
Forward transconductance <sup>a</sup>	g <sub>fs</sub>	V <sub>DS</sub> = 5V, I <sub>D</sub> = 3.6A		8		S
Diode forward voltage	V <sub>SD</sub>	I <sub>S</sub> = 0.94A, V <sub>GS</sub> = 0V		0.76	1.2	V
<b>Dynamic</b>						
Total gate charge	Q <sub>g</sub>	V <sub>DS</sub> = 10V, V <sub>GS</sub> = 4.5V, I <sub>D</sub> = 3.6A		4.0	10	nC
Gate-source charge	Q <sub>gs</sub>			0.65		
Gate-drain charge	Q <sub>gd</sub>			1.5		
Input capacitance <sup>b</sup>	C <sub>iss</sub>	V <sub>DS</sub> = 10V, V <sub>GS</sub> = 0V, f = 1MHz		300		pF
Output capacitance <sup>b</sup>	C <sub>oss</sub>			120		
Reverse transfer capacitance <sup>b</sup>	C <sub>rss</sub>			80		
<b>Switching<sup>b</sup></b>						
Turn-on delay time	t <sub>d(on)</sub>	V <sub>DD</sub> = 10V, R <sub>L</sub> = 5.5Ω, I <sub>D</sub> ≈ 3.6A, V <sub>GEN</sub> = 4.5V, R <sub>g</sub> = 6Ω		7	15	ns
Rise time	t <sub>r</sub>			55	80	
Turn-off delay time	t <sub>d(off)</sub>			16	60	
Fall time	t <sub>f</sub>			10	25	

**Notes :**

- a. Pulse Test : Pulse width ≤ 300μs, duty cycle ≤ 2%.
- b. These parameters have no way to verify.

# Typical Characteristics

BC2302

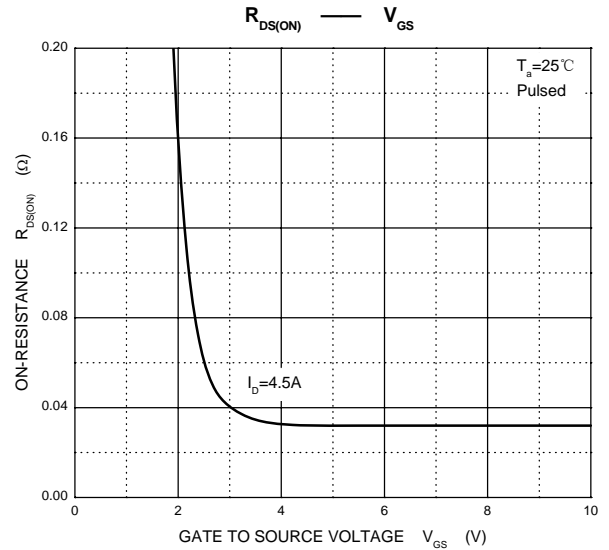
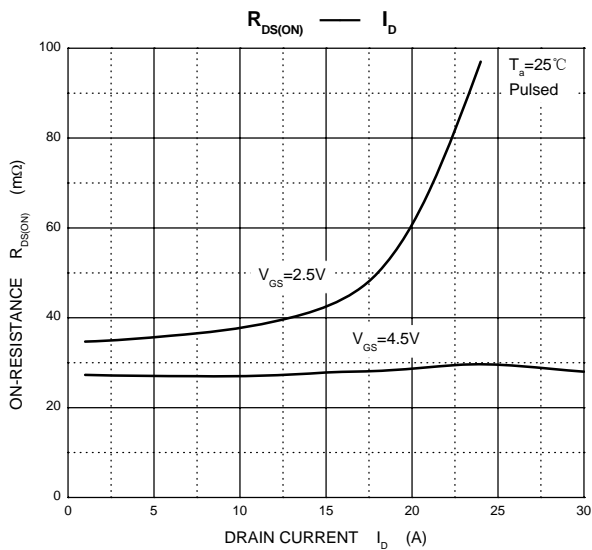
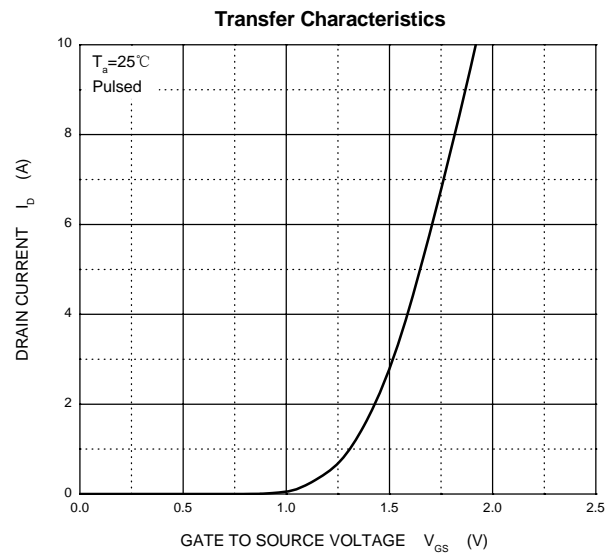
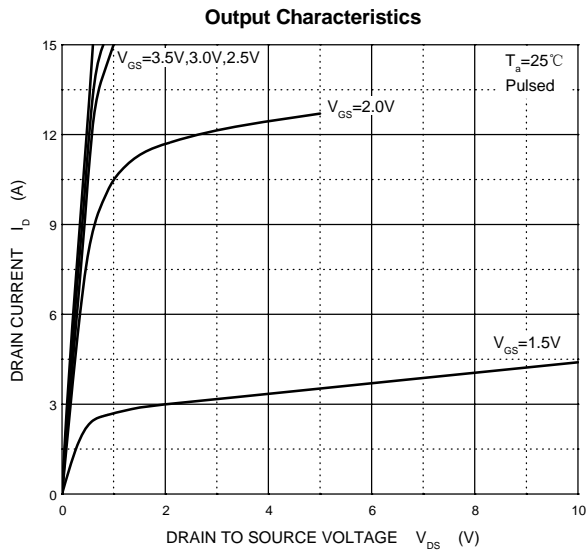



Package outline dimensions

SOT23-3L

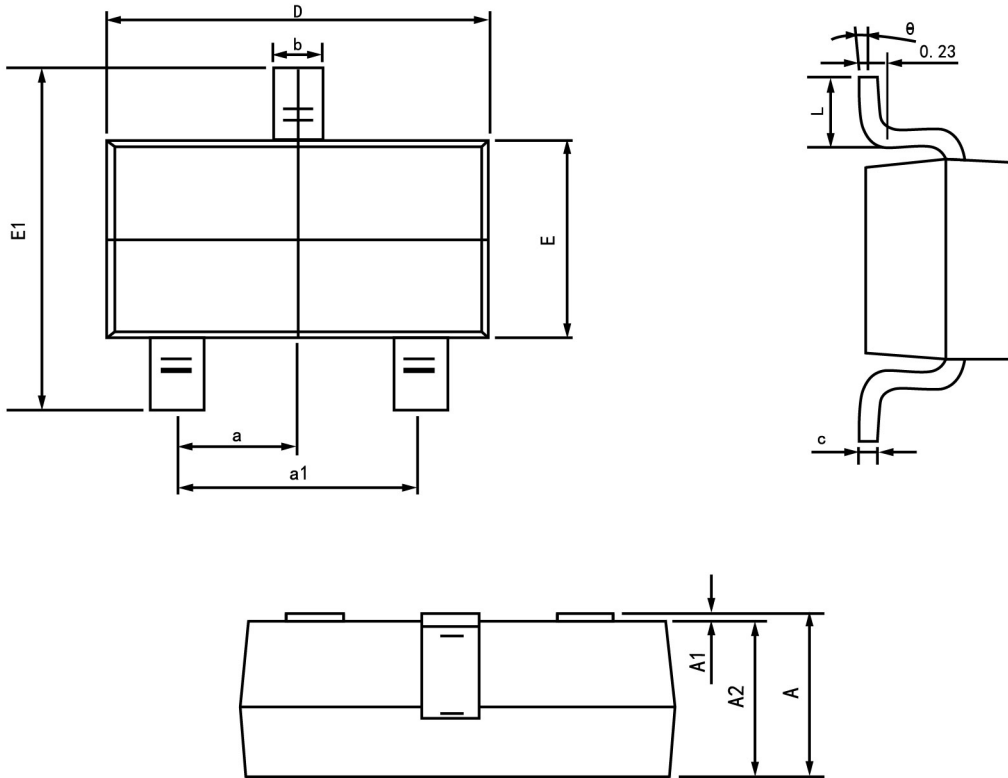

Symbol	Dimension in Millimeters	
	Min	Max
A	1.050	1.250
A1	0.000	0.100
A2	1.050	1.150
b	0.300	0.500
c	0.100	0.200
D	2.820	3.020
E	1.500	1.700
E1	2.650	2.950
e	0.950 (Basic)	
e1	1.800	2.000
L	0.300	0.600
theta	0°	8°