

Plastic-Encapsulate MOSFETS

N-Channel, 20V, 0.89A, Small Signal MOSFET

V_{DS} (V)	$R_{ds(on)}$ (Ω)	I_D (A)
20	0.220@ $V_{GS}=4.5V$	0.55
	0.260@ $V_{GS}=2.5V$	0.45
	0.320@ $V_{GS}=1.8V$	0.35

Descriptions

The BC2021W is N-Channel enhancement MOS Field Effect Transistor. Uses advanced trench technology and design to provide excellent $R_{DS(ON)}$ with low gate charge. This device is suitable for use in DC-DC conversion, load switch and level shift. Standard Product BC2021W is Pb-free.

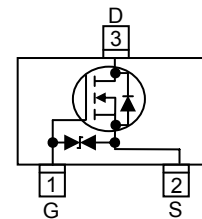
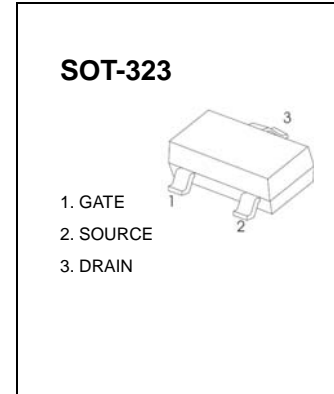

Pin configuration (Top view)

Features

- Trench Technology
- Supper high density cell design
- Excellent ON resistance
- Extremely Low Threshold Voltage
- Small package SOT-323

Applications

- DC-DC converter circuit
- Small Signal Switch
- Load Switch
- Level Shift

Marking = 21

Absolute Maximum ratings

Parameter		Symbol	10 S	Steady State	Unit
Drain-Source Voltage		V_{DS}	20		V
Gate-Source Voltage		V_{GS}	± 6		
Continuous Drain Current ^a	$T_A=25^\circ\text{C}$	I_D	0.89	0.82	A
	$T_A=70^\circ\text{C}$		0.71	0.65	
Maximum Power Dissipation ^a	$T_A=25^\circ\text{C}$	P_D	0.37	0.31	W
	$T_A=70^\circ\text{C}$		0.23	0.20	
Continuous Drain Current ^b	$T_A=25^\circ\text{C}$	I_D	0.78	0.70	A
	$T_A=70^\circ\text{C}$		0.62	0.56	
Maximum Power Dissipation ^b	$T_A=25^\circ\text{C}$	P_D	0.29	0.23	W
	$T_A=70^\circ\text{C}$		0.18	0.14	
Pulsed Drain Current ^c		I_{DM}	1.4		A
Operating Junction Temperature		T_J	150		$^\circ\text{C}$
Lead Temperature		T_L	260		$^\circ\text{C}$
Storage Temperature Range		T_{stg}	-55 to 150		$^\circ\text{C}$

Thermal resistance ratings

Parameter		Symbol	Typical	Maximum	Unit
Junction-to-Ambient Thermal Resistance ^a	$t \leq 10 \text{ s}$	$R_{\theta JA}$	275	335	$^\circ\text{C/W}$
	Steady State		325	395	
Junction-to-Ambient Thermal Resistance ^b	$t \leq 10 \text{ s}$	$R_{\theta JA}$	375	430	
	Steady State		445	535	
Junction-to-Case Thermal Resistance	Steady State	$R_{\theta JC}$	260	300	

- a Surface mounted on FR4 Board using 1 square inch pad size, 1oz copper
- b Surface mounted on FR4 board using minimum pad size, 1oz copper
- c Repetitive rating, pulse width limited by junction temperature, $t_p=10\mu\text{s}$, Duty Cycle=1%
- d Repetitive rating, pulse width limited by junction temperature $T_J=150^\circ\text{C}$.

Electronics Characteristics (Ta=25°C, unless otherwise noted)

Parameter	Symbol	Test Conditions	Min	Typ	Max	Unit
OFF CHARACTERISTICS						
Drain-to-Source Breakdown Voltage	BV_{DSS}	$V_{GS} = 0\text{ V}, I_D = 250\mu\text{A}$	20			V
Zero Gate Voltage Drain Current	I_{DSS}	$V_{DS} = 16\text{ V}, V_{GS} = 0\text{ V}$			100	nA
Gate-to-source Leakage Current	I_{GSS}	$V_{DS} = 0\text{ V}, V_{GS} = \pm 5\text{ V}$			5	μA
ON CHARACTERISTICS						
Gate Threshold Voltage	$V_{GS(TH)}$	$V_{GS} = V_{DS}, I_D = 250\mu\text{A}$	0.45	0.58	0.85	V
Drain-to-source On-resistance	$R_{DS(on)}$	$V_{GS} = 4.5\text{ V}, I_D = 0.55\text{ A}$		220	260	m Ω
		$V_{GS} = 2.5\text{ V}, I_D = 0.45\text{ A}$		260	310	
		$V_{GS} = 1.8\text{ V}, I_D = 0.35\text{ A}$		320	380	
Forward Transconductance	g_{FS}	$V_{DS} = 5\text{ V}, I_D = 0.55\text{ A}$		2.0		S
CHARGES, CAPACITANCES AND GATE RESISTANCE						
Input Capacitance	C_{ISS}	$V_{GS} = 0\text{ V}, f = 1.0\text{ MHz}, V_{DS} = 10\text{ V}$		50		pF
Output Capacitance	C_{OSS}			13		
Reverse Transfer Capacitance	C_{RSS}			8		
Total Gate Charge	$Q_{G(TOT)}$	$V_{GS} = 4.5\text{ V}, V_{DS} = 10\text{ V}, I_D = 0.55\text{ A}$		1.15		nC
Threshold Gate Charge	$Q_{G(TH)}$			0.06		
Gate-to-Source Charge	Q_{GS}			0.15		
Gate-to-Drain Charge	Q_{GD}			0.23		
SWITCHING CHARACTERISTICS						
Turn-On Delay Time	$t_d(ON)$	$V_{GS} = 4.5\text{ V}, V_{DS} = 10\text{ V}, R_L = 3\ \Omega, R_G = 6\ \Omega$		22		ns
Rise Time	t_r			80		
Turn-Off Delay Time	$t_d(OFF)$			700		
Fall Time	t_f			380		
BODY DIODE CHARACTERISTICS						
Forward Voltage	V_{SD}	$V_{GS} = 0\text{ V}, I_S = 0.35\text{ A}$	0.5	0.7	1.1	V



CHINA BASE
INTERNATIONAL

SOT-323 BC2021W



www.china-base.com.hk

Typical Characteristics (Ta=25°C, unless otherwise noted)

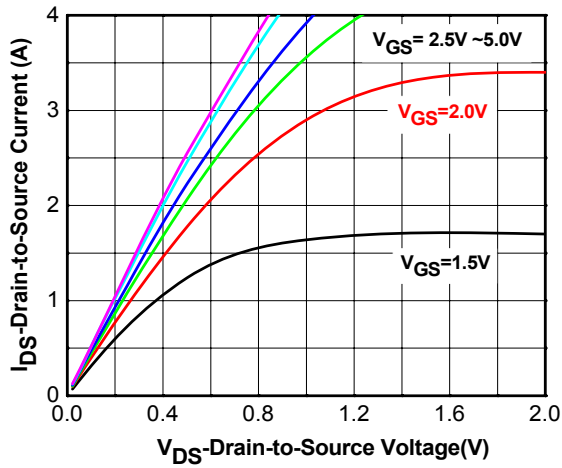

Output characteristics

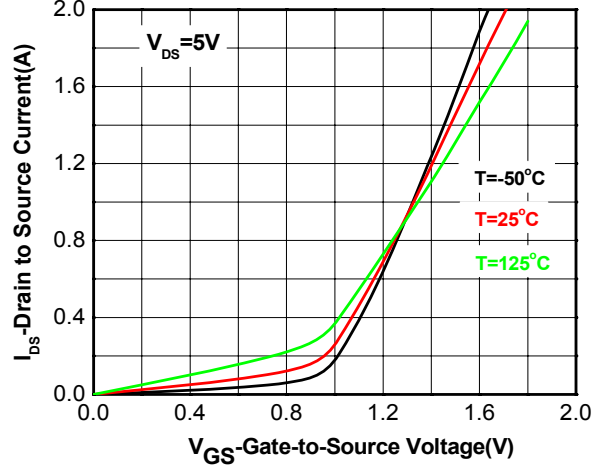

Transfer characteristics

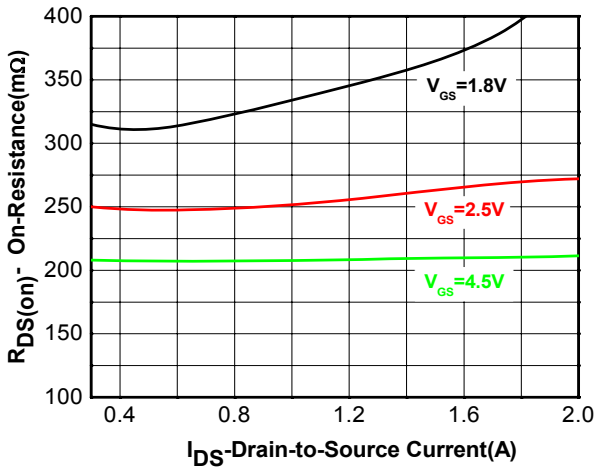

On-Resistance vs. Drain current

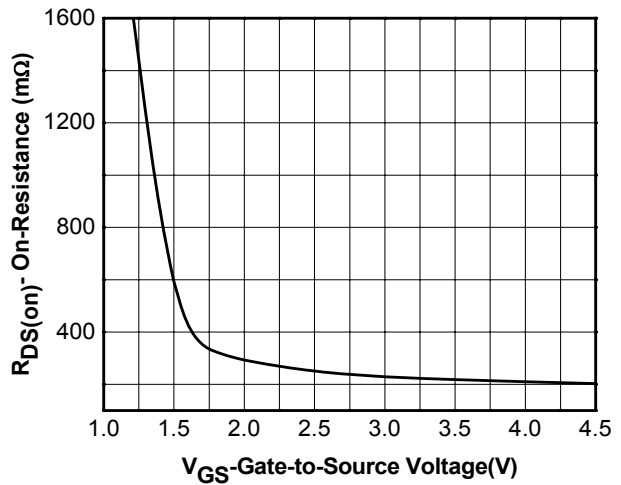

On-Resistance vs. Gate-to-Source voltage

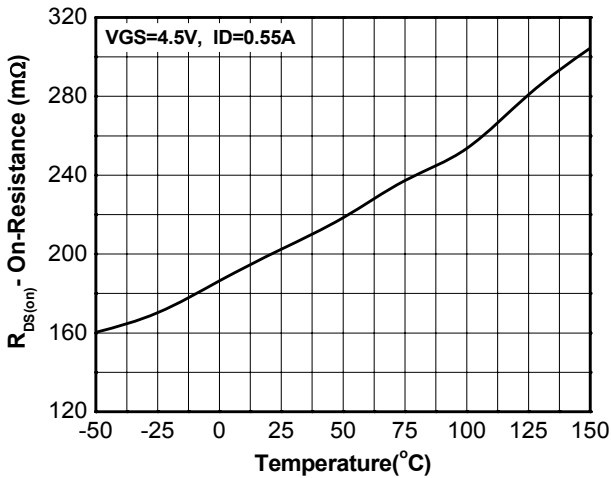

On-Resistance vs. Junction temperature

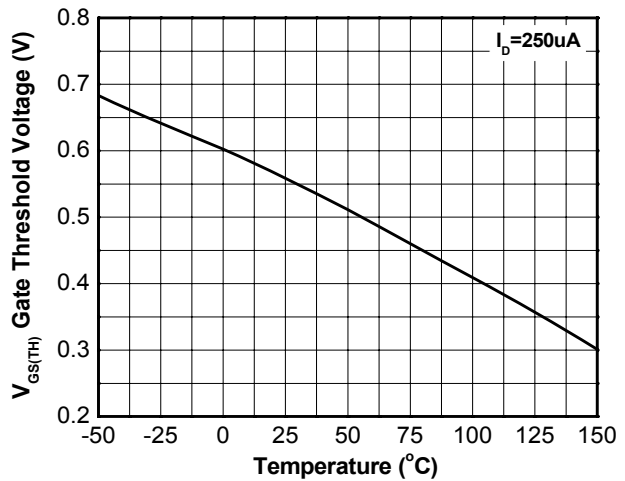

Threshold voltage vs. Temperature

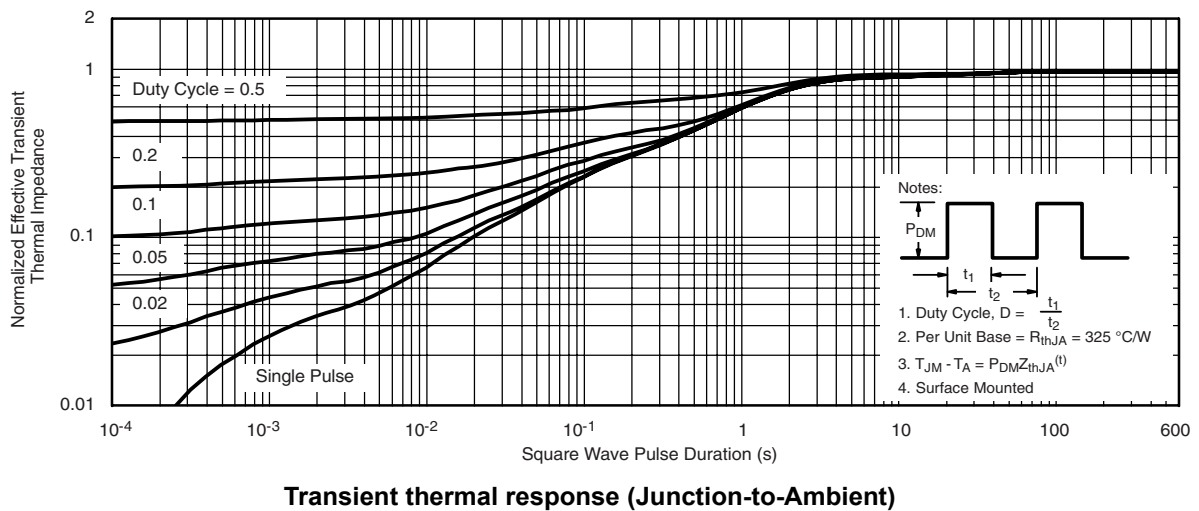
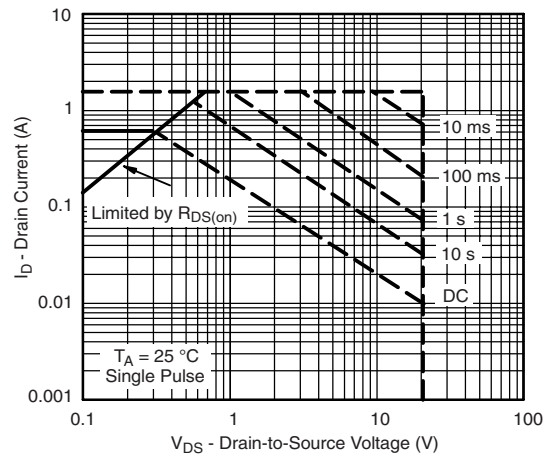
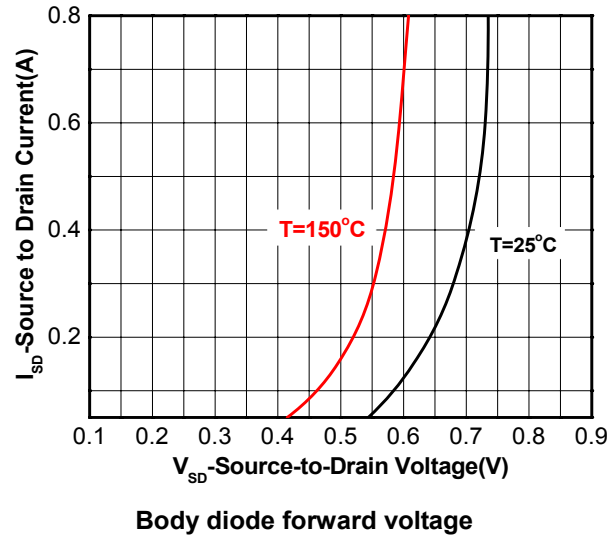
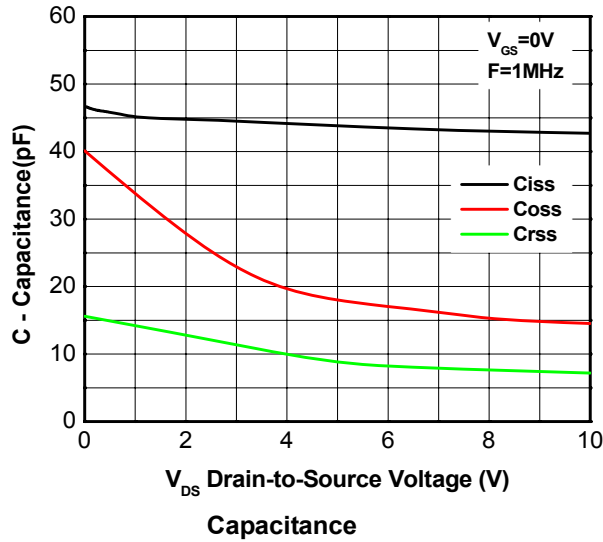



SOT-323 Package Outline Dimensions

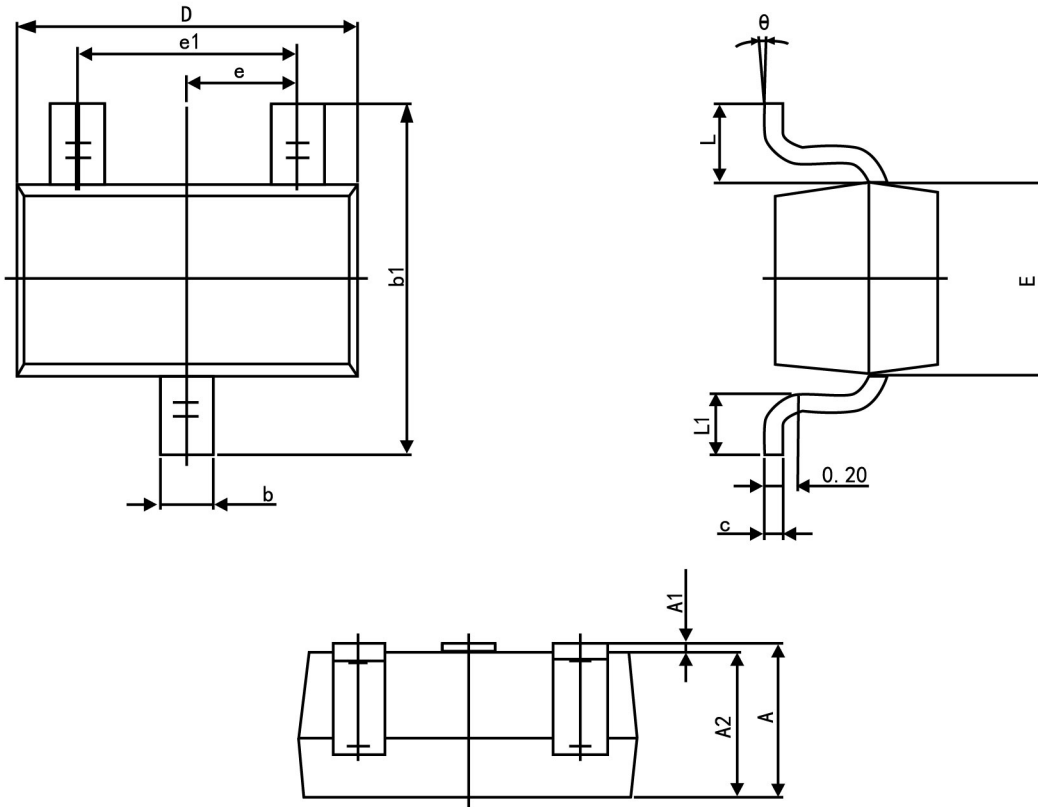

Symbol	Dimension in Millimeters	
	Min	Max
A	0.900	1.100
A1	0.000	0.100
A2	0.900	1.000
b	0.200	0.400
c	0.080	0.150
D	2.000	2.200
E	1.150	1.350
E1	2.150	2.450
e	0.650 TYP.	
e1	1.200	1.400
L	0.525 REF.	
L1	0.260	0.460
θ	0°	8°