

N-Channel Enhancement Mode Field Effect Transistor

Features

- Low on resistance $R_{DS(ON)}$
- Low gate threshold voltage
- Low input capacitance
- ESD protected up to 2KV

MARKING: 72K

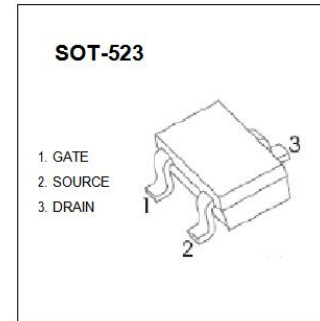
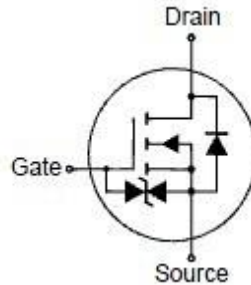

Absolute Maximum Ratings ($T_a = 25\text{ }^\circ\text{C}$)

Parameter	Symbol	Value	Unit
Drain-Source Voltage	V_{DSS}	60	V
Gate-Source Voltage	V_{GSS}	± 20	V
Drain Current (Continuous)	I_D	300	mA
Drain Current (Pulse Width $\leq 10\text{ }\mu\text{s}$)	I_{DM}	800	mA
Total Power Dissipation	P_{tot}	350	mW
Operating and Storage Temperature Range	T_j, T_{stg}	- 55 to + 150	$^\circ\text{C}$

Characteristics at $T_a = 25\text{ }^\circ\text{C}$

Parameter	Symbol	Min.	Max.	Unit
Drain Source Breakdown Voltage at $I_D = 10\text{ }\mu\text{A}$	BV_{DSS}	60	-	V
Zero Gate Voltage Drain Current at $V_{DS} = 60\text{ V}$	I_{DSS}	-	1	μA
Gate Source Leakage Current at $V_{GS} = \pm 20\text{ V}$	I_{GSS}	-	± 10	μA
Gate Threshold Voltage at $V_{DS} = 10\text{ V}, I_D = 250\text{ }\mu\text{A}$	$V_{GS(th)}$	1	2.5	V
Static Drain Source On-Resistance at $V_{GS} = 10\text{ V}, I_D = 500\text{ mA}$ at $V_{GS} = 4.5\text{ V}, I_D = 200\text{ mA}$	$R_{DS(ON)}$	- -	3 4	Ω
Forward Transconductance at $V_{DS} = 10\text{ V}, I_D = 200\text{ mA}$	g_{fs}	80	-	mS
Input Capacitance at $V_{DS} = 25\text{ V}, f = 1\text{ MHz}$	C_{iss}	-	50	pF
Output Capacitance at $V_{DS} = 25\text{ V}, f = 1\text{ MHz}$	C_{oss}	-	25	pF
Reverse Transfer Capacitance at $V_{DS} = 25\text{ V}, f = 1\text{ MHz}$	C_{rss}	-	5	pF

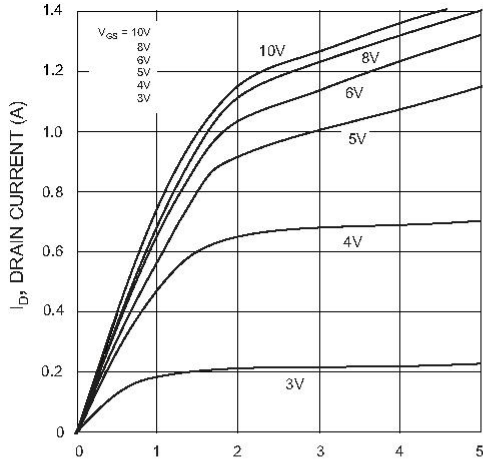

Fig. 1 Typical Output Characteristics

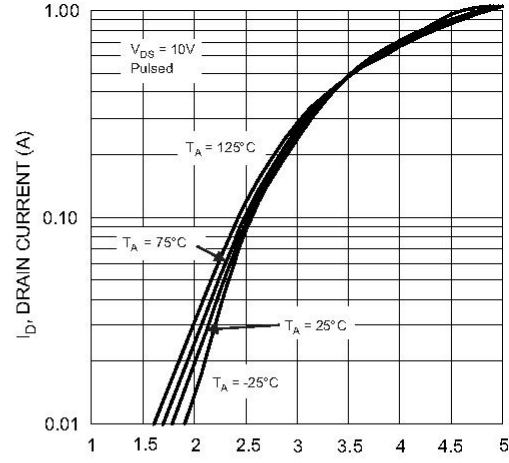

Fig. 2 Typical Transfer Characteristics

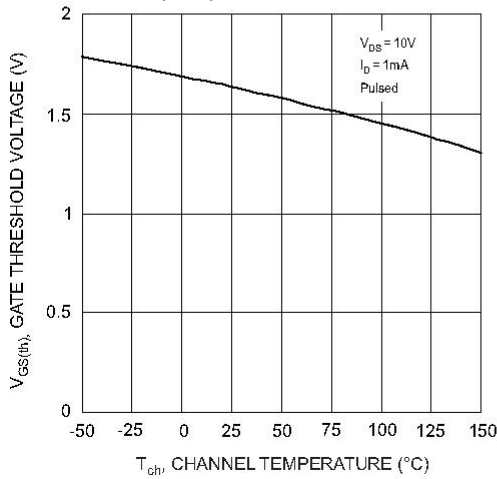

Fig. 3 Gate Threshold Voltage vs. Channel Temperature

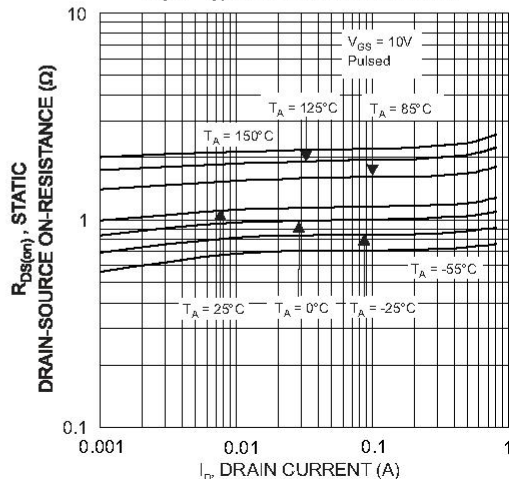

Fig. 4 Static Drain-Source On-Resistance vs. Drain Current

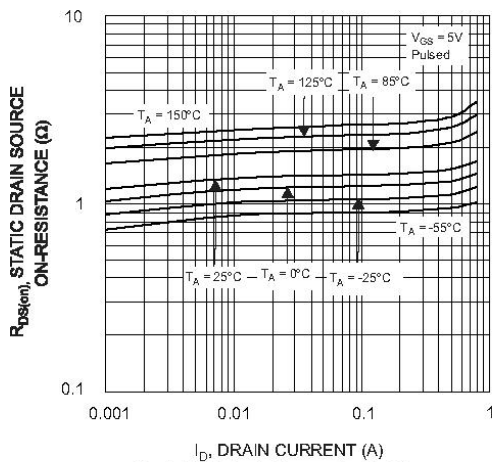

Fig. 5 Static Drain-Source On-Resistance vs. Drain Current

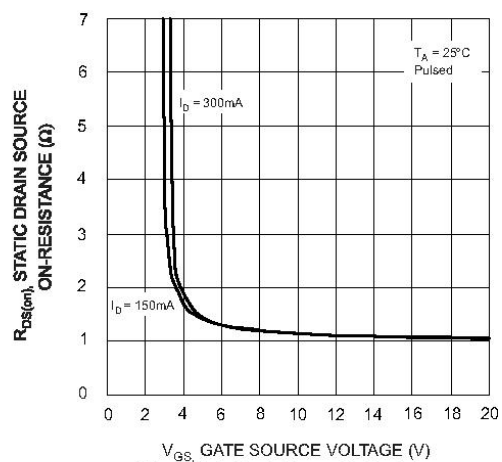

Fig. 6 Static Drain-Source On-Resistance vs. Gate-Source Voltage



PACKAGE OUTLINE

Plastic surface mounted package; 3 leads

SOT-523

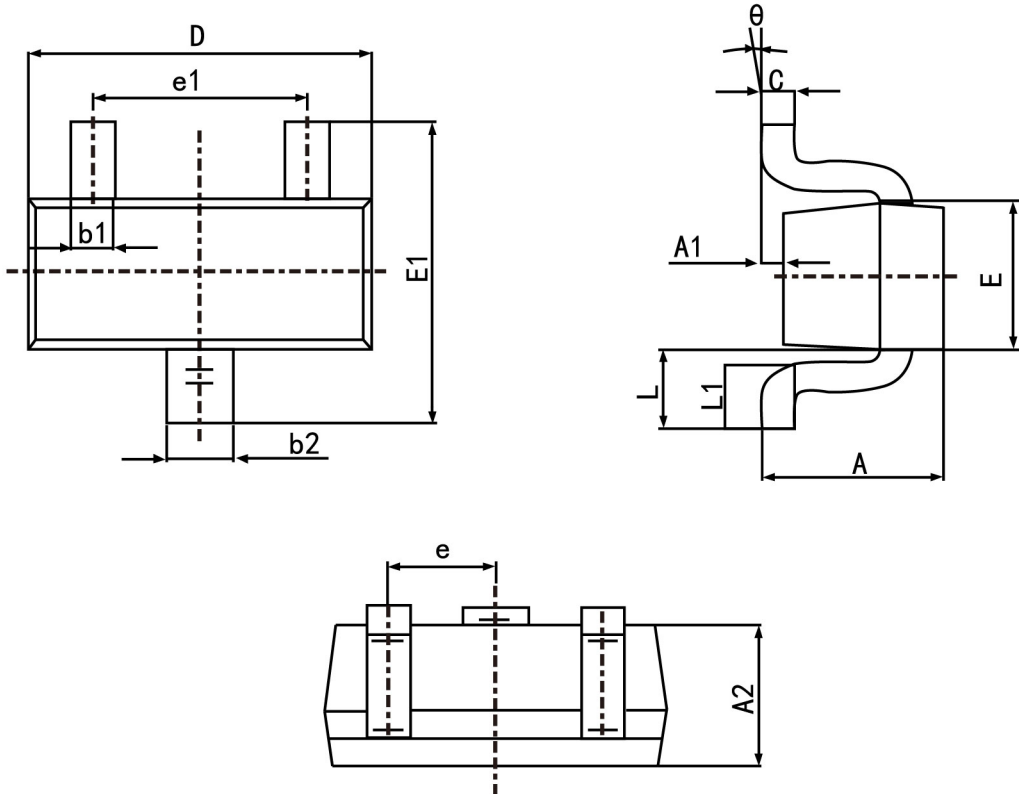

Symbol	Dimension in Millimeters	
	Min	Max
A	0.700	0.900
A1	0.000	0.100
A2	0.700	0.800
b1	0.150	0.250
b2	0.250	0.350
c	0.100	0.200
D	1.500	1.700
E	0.700	0.900
E1	1.450	1.750
e	0.500	TYP.
e1	0.900	1.100
L	0.400 REF.	
L1	0.260	0.460
θ	0°	8°